



E-LINE CCR

MANUAL



E-LINE CCR

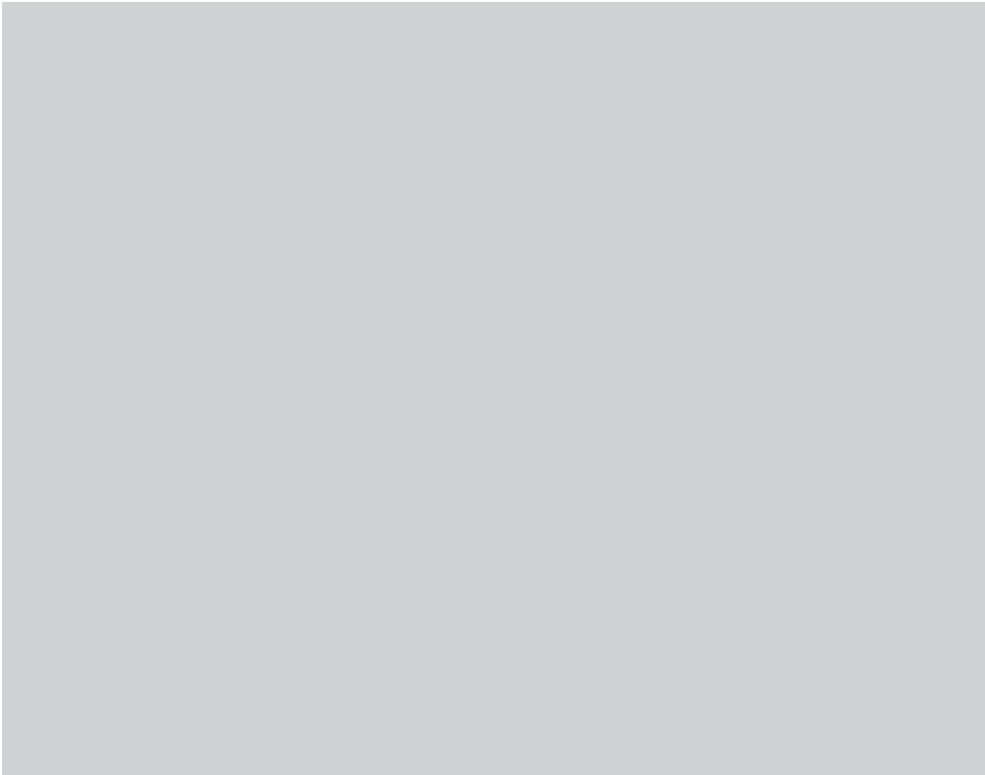

CONTENTS

►► E-LINE CCR

Introduction	2
General.....	3
Unloading, Handling and Storage of Products	4
Handling & Storage	5-6
Handling and Lifting.....	7
Joint Structure.....	8
Energizing	9
Project Design	10
Horizontal & Vertical CCR Busbar Applications.....	11
Fixing Elements	12-17
Equipment Used	18
Measuring a Special Length	19
Preparation of CCR Joint Flex-Comp	20-21
Installation / Horizontal	22-23
Installation / Edgewise	24-25
Installation / Vertical.....	26-27
Electrical site-tests	28
EAE Electrical Site Test Report	29-30
Declaration	31
Certificates	32
Product Overview	33-34

E-LINE CCR MANUAL

►► Introduction



Dear Customer

EAE Elektrik A.S. Products are designed to provide the maximum benefit in efficiency and service. Our products are manufactured in accordance with IEC standards and EAE is quality assured to ISO 9001 standards in their modern production plants in Istanbul .

The components that you have purchased are manufactured by a completely environment conscious, that is ISO 14001 certified.

These instructions should be read carefully and acted upon before taking delivery of equipment on site.

Handling, installation and operation of busbar systems should be carried out only by skilled, trained and authorized personnel using all associated equipment such as rubber gloves, helmet, safety glasses or face shields and flash resistant clothing in accordance with established safety practices.

The busbar system's successful operation depends on correct handling, installation, operation and maintenance. Improper installation may cause personal injury and the failure of the busbar system and damage to other property.



E-LINE CCR MANUAL

►► General



BUSBARS SHOULD NOT BE IN TOUCH WITH ANY LIQUID MATERIAL

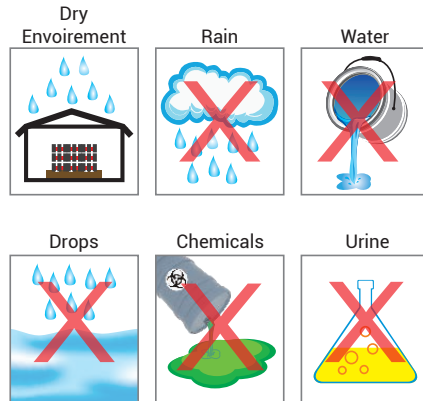

BUSBARS THAT ARE NOT ASSEMBLED COMPLETELY HAVE NO PROTECTION AGAINST TO WATER.



IT IS RECOMMENDED TO USE WITH A CANOPY IN OUTDOOR ENVIRONMENTS OF 40°C AND ABOVE.



E-LINE CCR MANUAL



►► Unloading, Handling and Storage of Products

Unloading:

- Forklift is the most reliable and easiest method for the unloading of the products from the container or the truck arriving at the worksite.
- Utmost care is required to be exercised to ensure avoidance of any harm that can be sustained by the products during the unloading process.

Storage:

- From the packing list check the number of pallets received, the number, dimensions and the condition of the busbar lengths. Advise any discrepancies immediately to the local EAE representative.
- All products should be stored in a dry environment. The casting materials for the joint must be stored at a temperature between 5 °C and 25 °C and not exposed to direct sunlight

Handling:

- Do not handle the materials using steel ropes or hooks. As shown in the castresin busbar should be lifted using lifting straps placed at each end of the busbar length.
- Short modules may be lifted using a single strap providing that the piece is balanced.
- A wooden spacer should be used every 1.5m when storing the lengths placed on top of each other.
- Do not stack more than 5 modules on each other horizontally.

► Joint Area General Information

Pre-Cast Controlling of Juncture Area:

- The final check form supplied should be completed for each busbar joint installed.
- Perform a megger test after each joint, and ensure that there is no problem on the joint area.
- In order to prevent damage to the terminals and transformers during this test, remove their connections or protect them.
- After every electrical test, the system must be discharged to earth.
- After completing all electrical tests, make the terminal, MCCB and fuse connections again.
- The form filled in after each test should be submitted to the EAE representative. The product quality approval form (186) should be completed and submitted to us to validate the warranty.

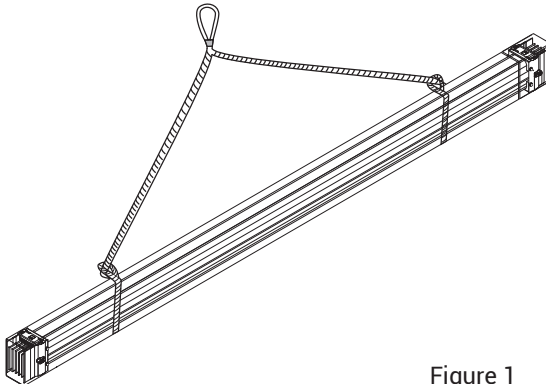

Figure 1

E-LINE CCR MANUAL

►► Handling & Storage



Introduction:

This installation manual includes the details of safe and quick handling and installation of cast resin busbar product. It shall be read carefully before starting the procedures on the product and relevant steps shall be followed.

Things To Do:

1. Read the info note on the pallet; lift and handle the the product as shown in "Figure 1" taking the pallet weight into consideration.
2. Product shall be hanged and lifted as shown in "Figure 2" while it is handled. (Figure 2)
3. Resin and hardener shall be stored as shown in Figure 3.
4. Busbar route shall be marked before starting the installation.
5. Installation shall start from a single point (preferably panel) and shall be completed with the last module.
6. Do not perform casting before performing megger test on the joint and observing infinite resistance as the result of the test.
7. Do not apply expired joint casting agent.

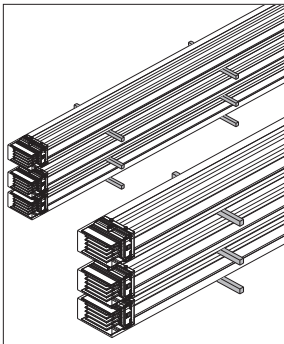

Figure 1

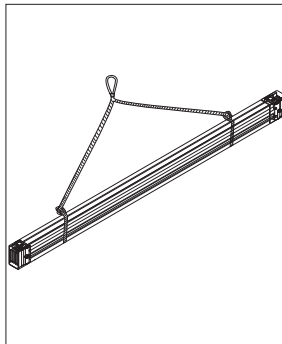

Figure 2

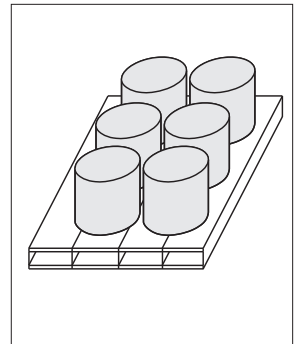

Figure 3

E-LINE CCR MANUAL

▶▶ Handling & Storage



1- General guidelines are given to protect the busbar straight lengths and modules and reduce the risk of personal injury and equipment damage during handling on site.

2- As soon as the container or truck arrives on site, a suitable forklift is required for easy and convenient unloading from vehicle directly to the ground level.

3- All pallets should be checked by unpacking them sufficiently to inspect them for possible transit damage and to determine that the shipment is complete and correct as per Packing List provided.

* If any of the items is missing from the Packing List or any piece is damaged during transportation, Insurance Company must be informed immediately for proper reporting with all required documents for further action.

4- All busbar straight lengths and modules should be handled with care to avoid damage to internal components and the twisting of housing or its finish.



5-When the lengths and modules are required to be taken from the pallets to the erection area, those should be hoisted using metal rods or bars passed through the 2 sets of holes at each end of the housing body by ensuring the load is stable and safely secured. Then adequate sling and slinging method can be used for shifting from one place to another.

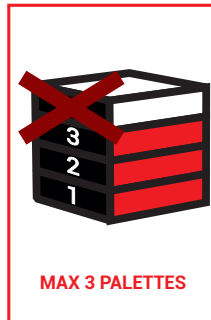

E-LINE CCR MANUAL

►► Handling and Lifting



Strapping type ropes should only be used instead of round ropes to prevent the materials slipping during handling.

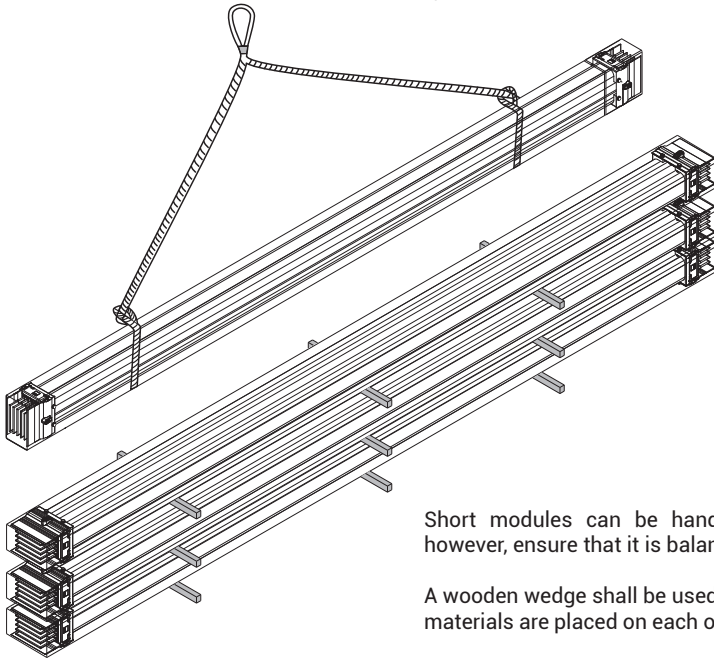
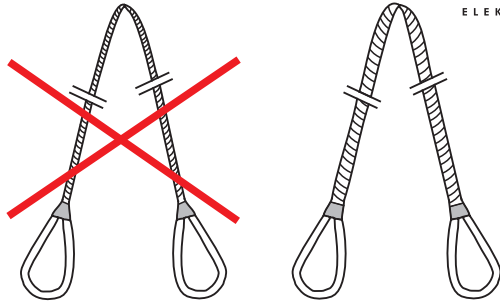

Short modules can be handled by a single rope, however, ensure that it is balanced.

A wooden wedge shall be used every 1.5 m when the materials are placed on each other while storing them.

Do not put more than 5 modules on each other horizontally.

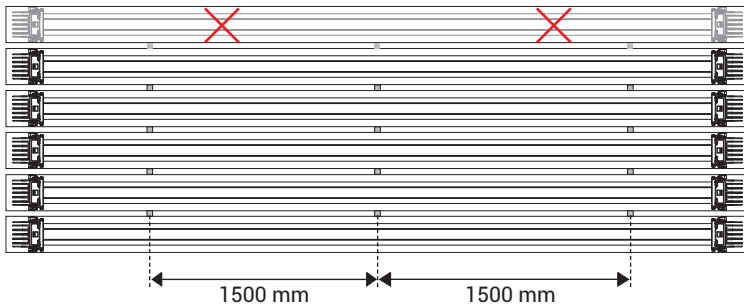

E-LINE CCR MANUAL

►► Joint Structure

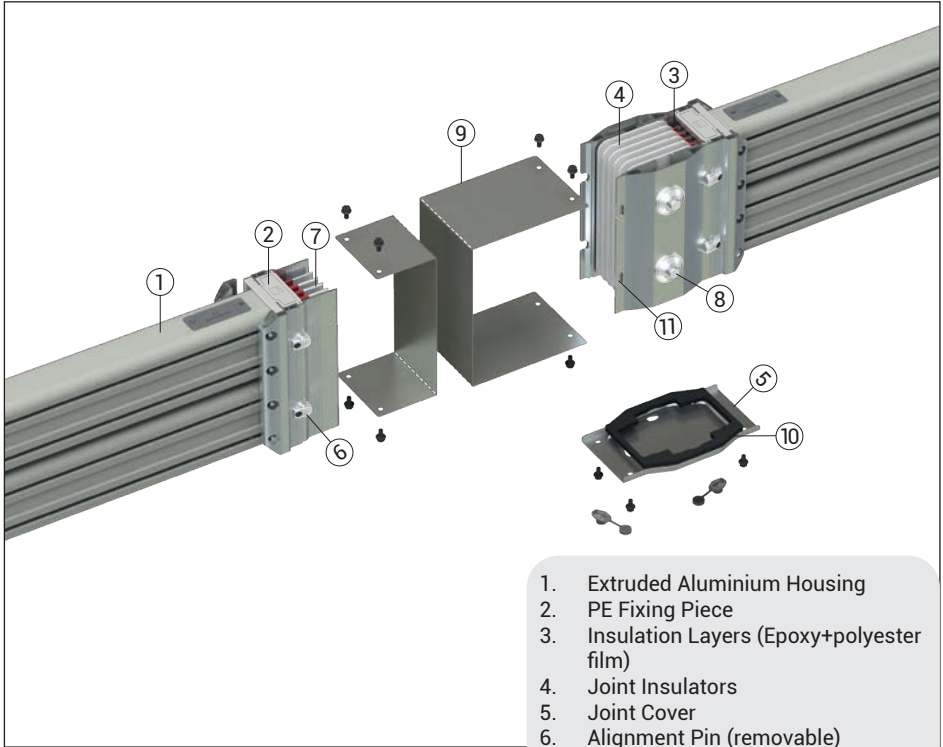

1. Extruded Aluminium Housing
2. PE Fixing Piece
3. Insulation Layers (Epoxy+polyester film)
4. Joint Insulators
5. Joint Cover
6. Alignment Pin (removable)
7. Conductors
8. IP55 Nut Locking Piece
9. Cover plates
10. IP55 Joint Cover Gasket
Protectivecovers 10 are discarded
11. Alignment Pin Slot NB

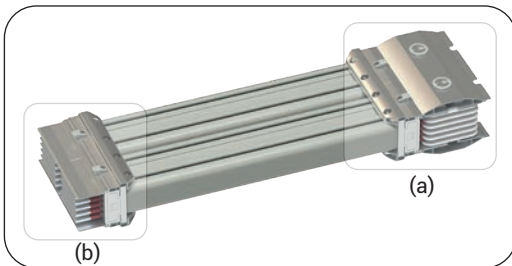

CCR Busbars are manufactured in 3m standard lengths, however special lengths can be manufactured according to the project diagrams. All modules have a block joint end and no block joint on the opposite end.

▶ Before Energizing

1-All busbar ratings, routings and supporting systems should be checked as per final isometric drawings.

2-All busbar system should be checked visually to be certain that they are clean and secure. Loose and/or contaminated connections increase electrical resistance which can cause overheating.

3-Any type of blower or compressed air should not be used to avoid blowing dust into busbar joints, tap off boxes or circuit breakers. If there is accumulation of dust and dirt, clean it off by using a soft brush, vacuum cleaner, or clean lint free rags.

4-All joints should be correctly tightened according to the torque value given and should be marked. Then install the locking plates correctly.

5-All Tap Off boxes fed from the busbar should be on "OFF" position.

6-The busbar runs should be isolated by disconnecting all connection

7-Insulation resistance test with an insulation resistance test equipment rated 1000V DC should be conducted to verify the integrity of the system. This test should be performed between phases, neutral and earth. Permanent records should be kept of resistance readings. If the insulation reading appears to be lower than 1 megaohm, then the cause should be investigated.

8-The system phase sequence should be checked in order to match the busbar phases sequence before reconnecting all connections to transformers, switchboards, meters, etc.

E-LINE CCR MANUAL

►► Project Design

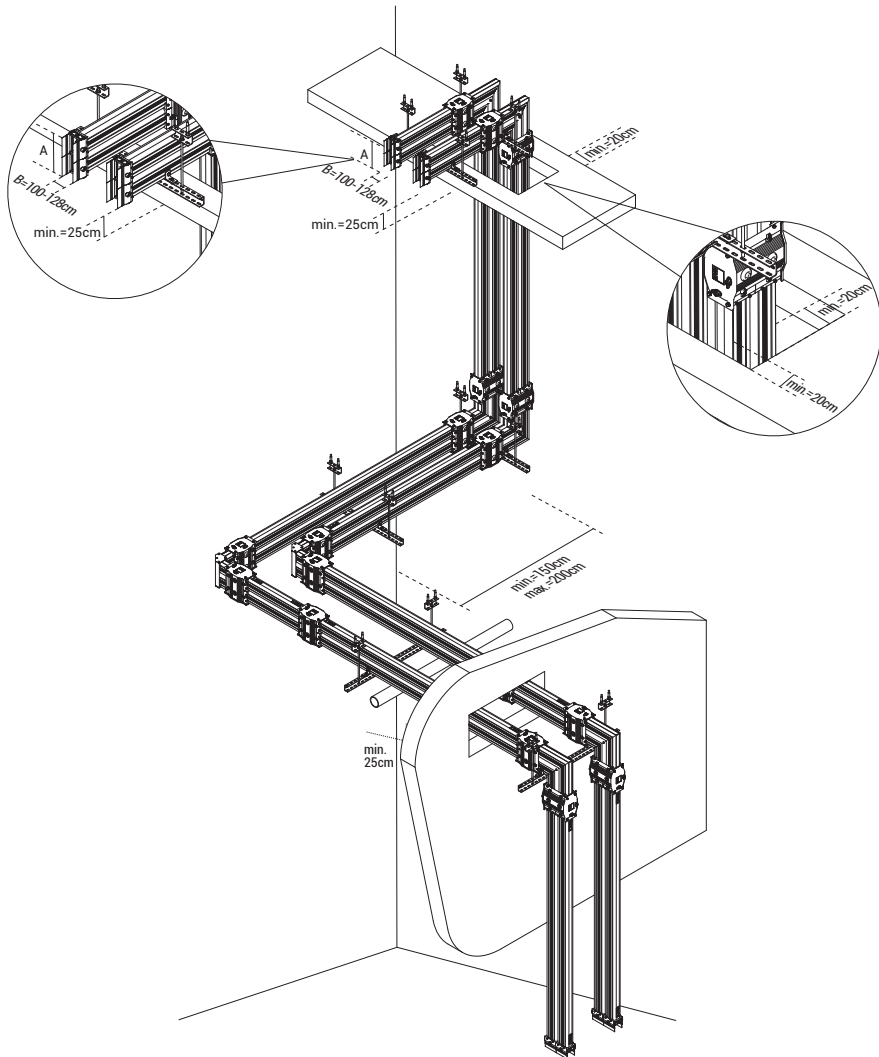

In multipath busbars in high-rise vertical shaft applications; Due to floor heights, floor thickness and product tolerances, the window or additional point alignments on the upper floors may not be the same. In order for the Tap off boxes to be aligned and the joint point not to coincide with the floor transitions, the assembly should be continued by making measurements on each floor.

■ EAE is not responsible for the potential risks that may occur in cases where the products in our catalogue are used outside of the standard phase sequences as shown in the catalogue.

E-LINE CCR MANUAL

►► Horizontal & Vertical CCR Busbar Applications



Figure 1 - Edgewise Application

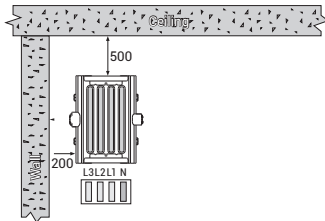

Figure 2 - Edgewise Application

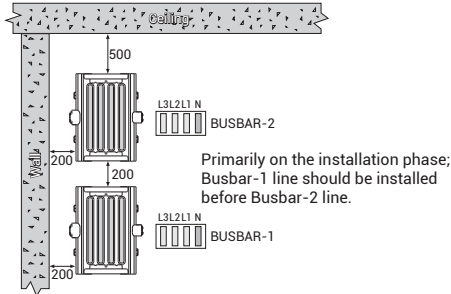

Figure 3 - Flatwise Application

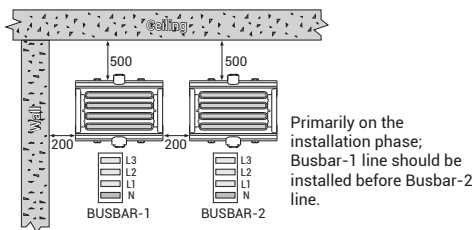

Figure 4 - Crossing Under A Beam On Edgewise Application

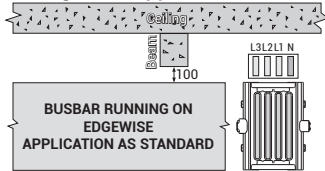

Figure 5 - Crossing Under A Beam On Flatwise Application

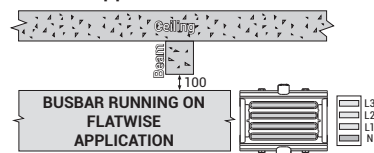

Figure 6 - Sample Wall Crossing With Fire Barrier

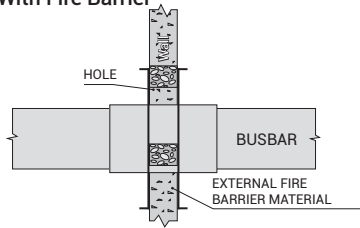

Figure 7 - Standard Wall Crossing

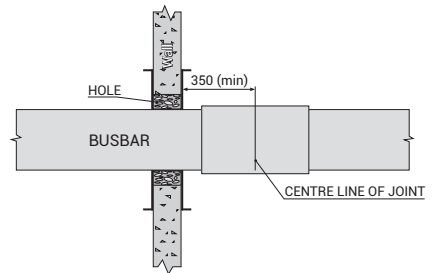

Figure 8 - Edgewise application in gallery

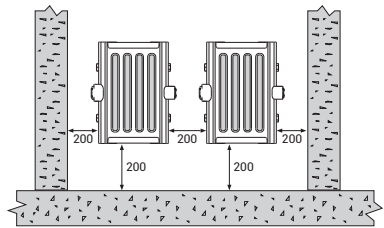
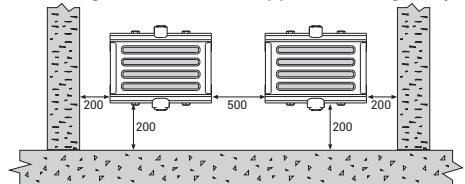

Figure 9 - Flatwise application in gallery



Attention!

- For correct installation, the dimension from the busbar to the ceiling should not be less than 500mm
- The joint should be not come across to Beams.
- The dimensions given above are minimum values.
- All dimensions are given in mm.

E-LINE CCR MANUAL

►► Fixing Elements



► Vertical Shaft Type Carriers

CCR Vertical Riser Fixing Unit

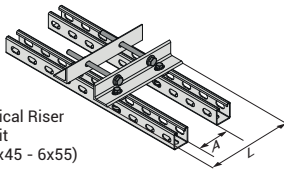
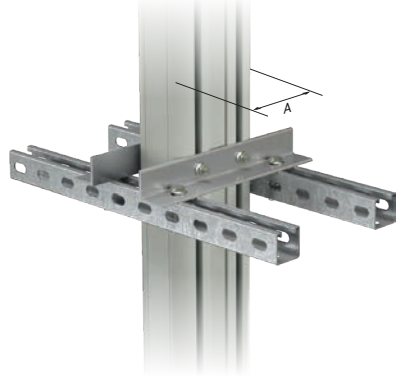
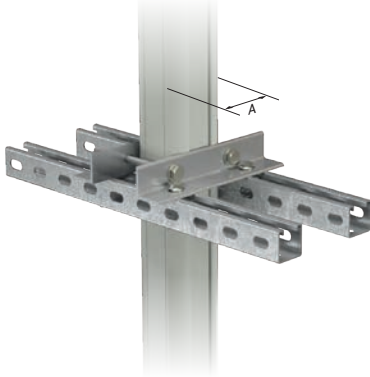

CCR-Vertical Riser Fixing Unit (6x40 - 6x45 - 6x55)

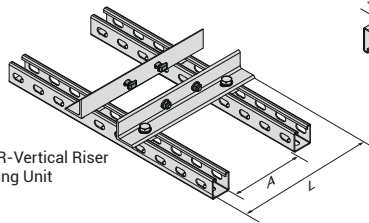

CCR-Vertical Riser Fixing Unit

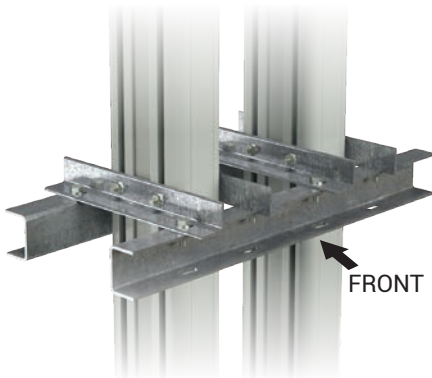
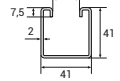
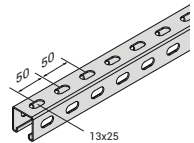

Vertical Riser Application Sample Order Hanging (Special to project)

E-LINE CCR MANUAL

►► Fixing Elements



► Ceiling Type Supports

CCR-UT Two-Way For Edgewise Application To NPI Channel

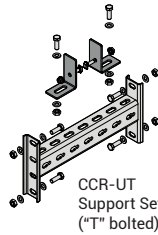
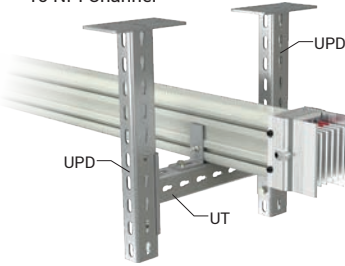

► Floor Type Supports

CCR-UT Two-Way For Edgewise Application To NPI Channel

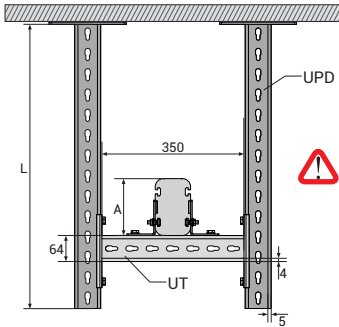
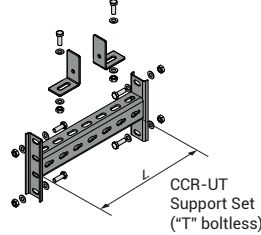
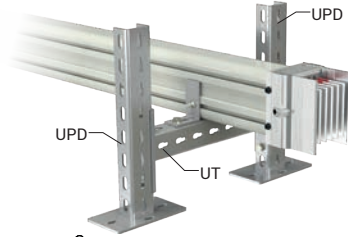

⚠ When selecting an UPD product, please keep in mind to select the UPD product suitable to the Busbar A dimension.

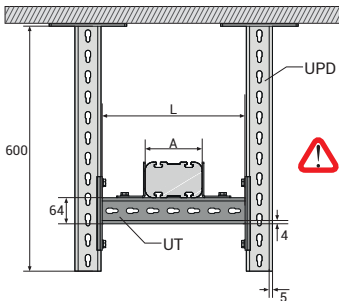
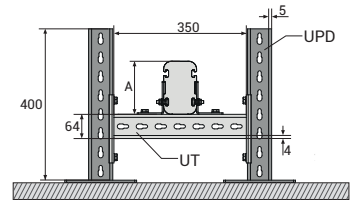

⚠ When choosing CCR-UT Suspension Set, appropriate CCR-UT Suspension Set should be selected according to Busbar size.

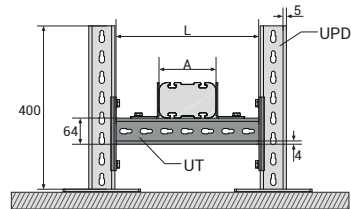

■ *Flatwise Application is supplied for only on special conditions.

■ Please call us for non-standard dimensions.

E-LINE CCR MANUAL

►► Fixing Elements



► Heavy Duty Supports (U)

Hot Dip Galvanized After Fabrication (TS EN ISO 1461)

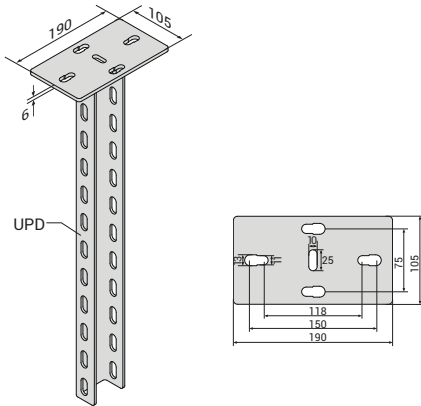

⚠ When selecting an UPD product, please keep in mind to select the UPD product suitable to the Busbar A dimension.

► CCR-UT Suspension Assembly

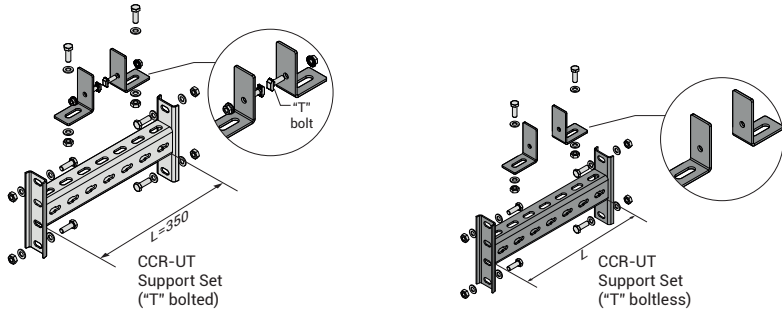

⚠ When choosing CCR-UT Suspension Set, appropriate CCR-UT Suspension Set should be selected according to Busbar size.

■ Please check our Suspension Systems (A-A) Catalogue to see our alternative solutions for suspension types.

■ The dimensions given above are minimum values.

■ Please call us for non-standard components.

■ All measures are given in mm.

E-LINE CCR MANUAL



►► Fixing Elements

► Ceiling Type Supports

CCR-IDY Two-Way For Edgewise Application To NPI Channel

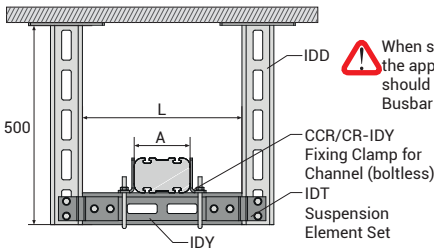
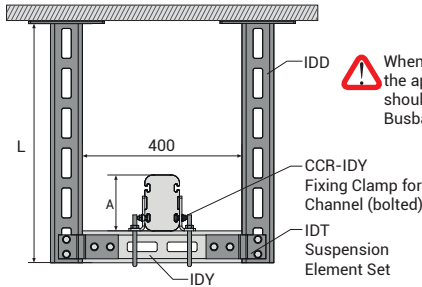
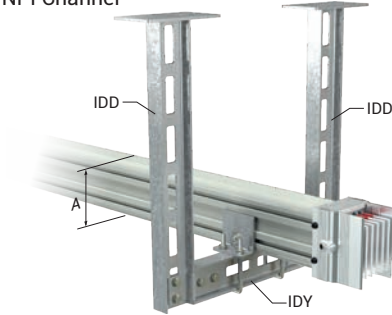

► Floor Type Supports

CCR-IDY Two-Way For Edgewise Application To NPI Channel

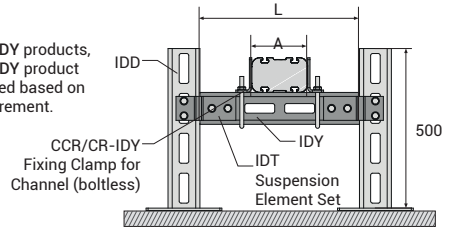
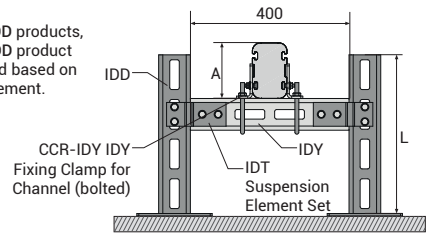
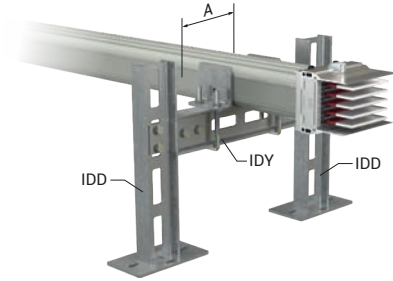

► Supports

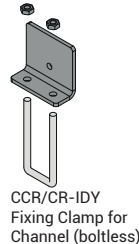
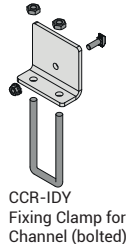
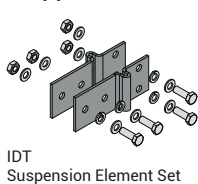

■ Please check our Suspension Systems (A-A) Catalogue to see our alternative solutions for suspension types.

■ The dimensions given above are minimum values.

■ Please call us for non-standard components.

■ All measures are given in mm.

E-LINE CCR MANUAL

►► Fixing Elements



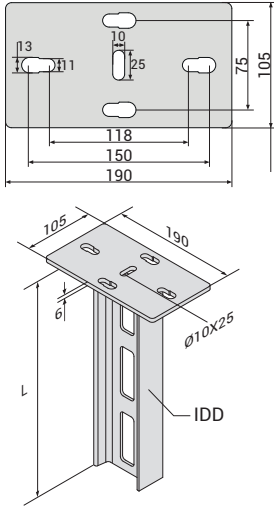

► IDD Type Supports

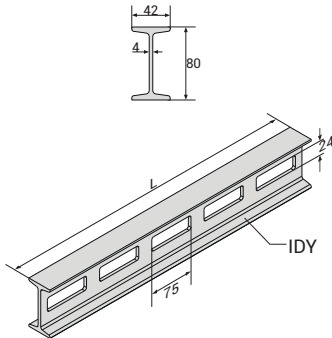

 When selecting IDD products, the appropriate IDD product should be selected based on Busbar A measurement.

► IDY Type Supports



 When selecting IDY products, the appropriate IDY product should be selected based on Busbar A measurement.

■ Please check our Suspension Systems (A-A) Catalogue to see our alternative solutions for suspension types.

■ The dimensions given above are minimum values.

■ Please call us for non-standard components.

■ All measures are given in mm.

E-LINE CCR MANUAL

►► Fixing Elements



► Ceiling Type Supports

CCR-Threaded Rod Two-Way For Edgewise Application To NPI Channel

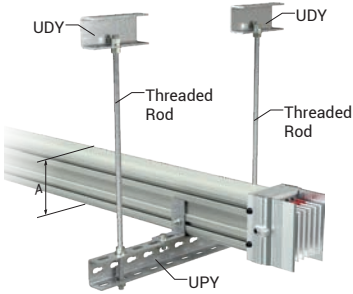

CCR-Threaded Rod Two-Way For Flatwise Application To NPI Channel

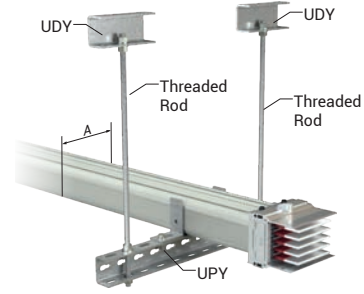

► Supports

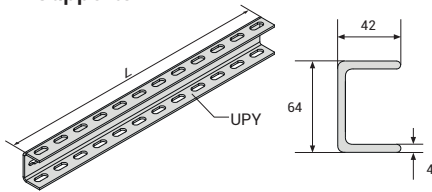

CCR-L Suspension Set

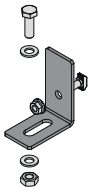

CR-L Suspension Connection Set

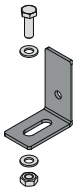

Fixing Elements

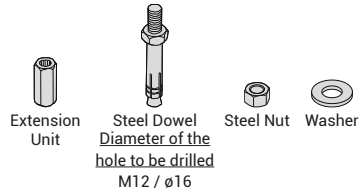
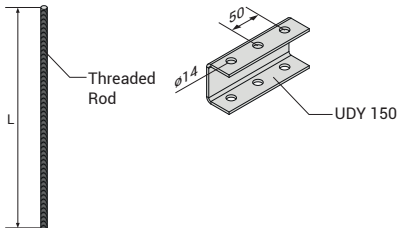

■ Please check our Suspension Systems (A-A) Catalogue to see our alternative solutions for suspension types.

■ The dimensions given above are minimum values.

■ Please call us for non-standard components.

■ All measures are given in mm.

E-LINE CCR MANUAL

►► Equipment Used

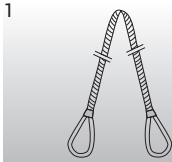

Fabric Crane Ropes

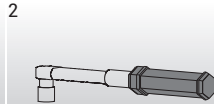

Torque Wrench

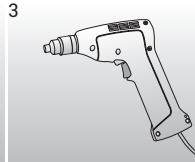

Hot Air Blower

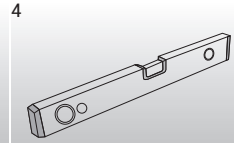

Spirit Level

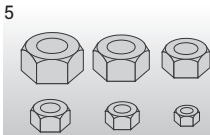

Nut Set

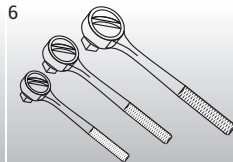

Socket Set

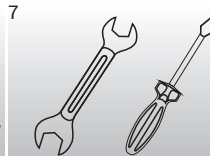

Wrench, Screwdriver



Lifting Device
(forklift truck, crane, hoist
etc.)

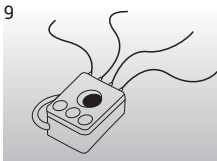

Megger Device

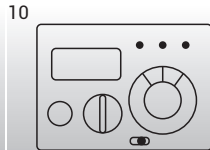

Dielectric Test Device
5 kV DC



Scaffold



Mixer

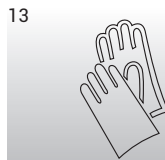

Protective
Clothes,
Gloves, Goggles

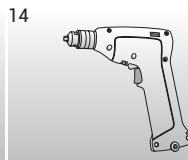

Drill

E-LINE CCR MANUAL

►► Measuring a Special Length



After installation of standard busbar 3m lengths, you will be in need of special lengths which are smaller than 3m. The minimum length for these special elements can be 450mm. Please measure the lengths of these modules as shown below.

Length A is measured between housing of 2 busbars in mm. A. The special length is calculated by deducting 290mm from this measured length.

$$X = A - 290\text{mm}$$

X = Length of Special Busbar

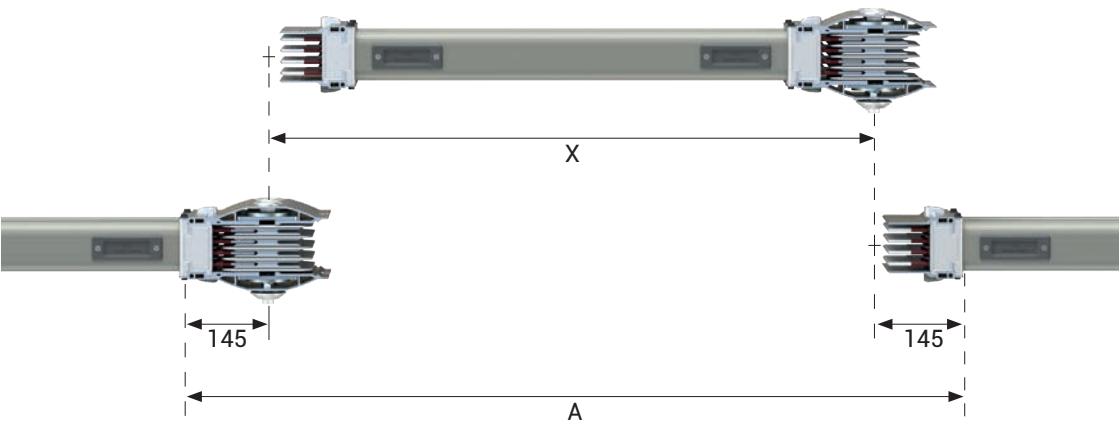

E-LINE CCR MANUAL

►► Preparation of CCR Flex-Comp



► Preparation of Flex-Comp

The meger test must be carried out before casting. If Flex-Comp (A) and Flex-Comp (B) are stored in a cold environment, they should be kept in a warm environment one day before casting ($> 20^{\circ}\text{C}$). Ambient temperature during casting should be $5^{\circ}\text{C} < T_{\text{casting}} < 35^{\circ}\text{C}$.

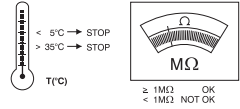

Preparation of Flex-Comp



Flex-Comp (A)



Flex-Comp (B)



Flex-Comp (A)
(1,75kg)

Flex-Comp (B)
(1,75kg)



Add Flex-Comp (B) product into Flex-Comp (A). One set is 3.5 kg. The required kg values for filling the joints according to their cross-section are indicated in the table next to it. The number of sets to be prepared should be calculated based on the number of joints in the assembly time.

Mix the mixture with a beater at low speed for at least 30sec - 1 minutes until it is homogeneous.

E-LINE CCR MANUAL

►► Preparation of CCR Flex-Comp



Amount of Resin to be Used

CCRA - Al Conductor		CCRC - Cu Conductor		Conductor	3 Conductor (kg)	4 Conductor (kg)	4½ - 5 Conductor (kg)
Rated Current	Busbar Code	Rated Current	Busbar Code				
600	06	650	06	6x40	1,1	1,3	1,4
-	-	850	08	6x45	1,2	1,4	1,7
-	-	1000	10	6x55	1,2	1,5	1,5
800	09	1250	12	6x80	1,4	1,6	1,8
1000	10	-	-	6x95	1,5	1,8	2,0
1250	12	1600	16	6x110	1,6	1,9	2,1
-	-	2000	20	6x150	1,9	2,3	2,6
1600	16	-	-	6x160	2,0	2,4	2,7
2000	21	-	-	6x230	2,5	2,9	3,3
-	-	2500	25	2(6x80)	2,3	2,7	3,0
-	-	3200	32	2(6x110)	2,8	3,3	3,5
-	-	3400	34	2(6x125)	3,1	3,6	4,0
2500	25	-	-	2(6x130)	3,2	3,8	4,1
-	-	4000	40	2(6x140)	3,3	3,9	4,2
3000	31	-	-	2(6x160)	3,7	4,3	4,9
3300	33	4500	45	2(6x180)	4,2	4,7	5,3
3600	37	-	-	2(6x200)	4,4	5,1	5,7
4000	41	-	-	2(6x230)	4,7	5,4	5,9
4500	44	-	-	2(6x250)	4,8	5,5	6,0
-	-	5000	50	3(6x125)	4,5	5,2	5,7
-	-	5750	57	3(6x160)	5,4	6,2	6,9
5000	50	6300	63	3(6x180)	6,1	7,0	7,6
5400	54	-	-	3(6x200)	6,7	7,6	7,8

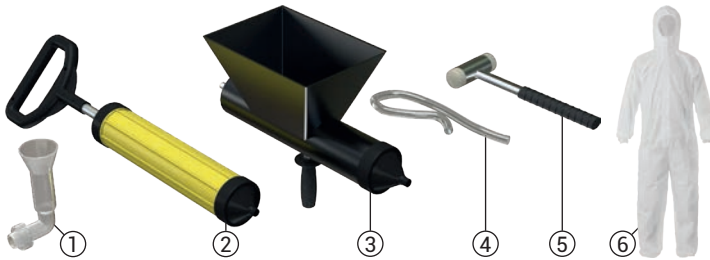

CCR Flex-Comp Mixer

Description	Order Code
CCR Flex-Comp Mixer	5002396



Casting Materials

No	Açıklama	Order Code
1	CCR Level Check Pipei	3271279
2	CCR Injection Pomp	3254100
3	Flex-Comp Casting Apparatus	5003447
4	Flex-Comp Transparent Hose Set	5003607
5	CR Plastic Hammer	5000310
6	Disposable Protective Overall	5003622

E-LINE CCR MANUAL

►► Installation / Horizontal

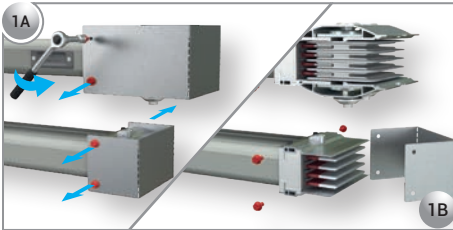

Remove the busbar protection covers by unscrewing the bolts

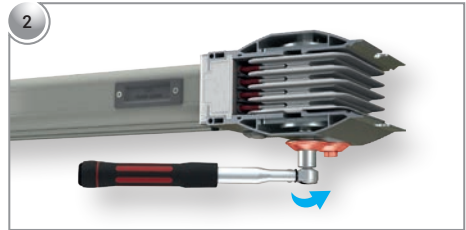

Remove the nut locking cover.

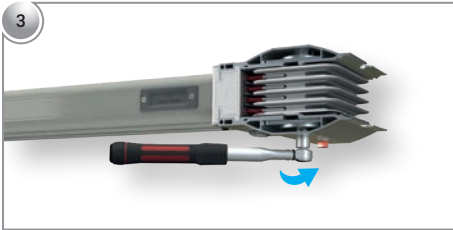

Loosen the block splice nuts.

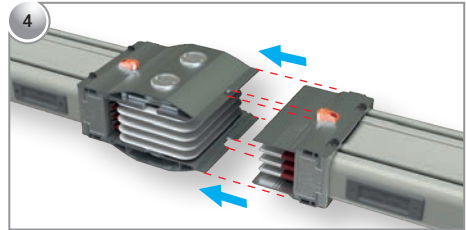

Verify the orientation and compatibility of the busbars and alignment components to be added. Connect the busbars with the small alignment components on top.

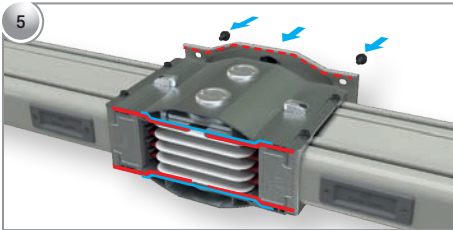

Install the block joint cover to align the busbars, tightening the cover bolts to a moderate torque. Adjust until the busbars fit perfectly into the alignment slots.

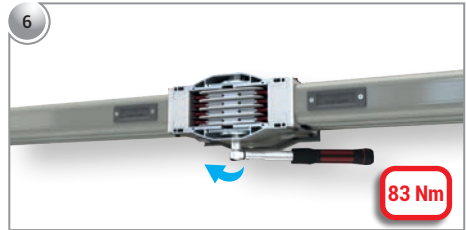

After verifying alignment, torque the block joint nuts to 83 Nm.

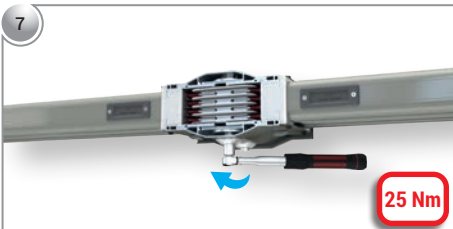

Reinstall the nut locking covers and torque with 25 Nm.

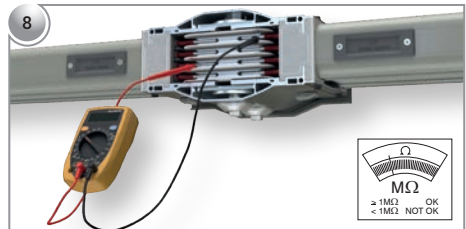

Perform an insulation resistance test between all phases at the installed block joint point.



E-LINE CCR MANUAL

►► Installation / Horizontal

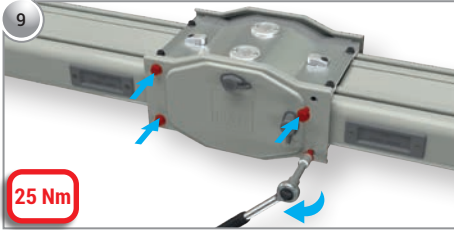

Install the other block joint cover and torque its bolts to 25 Nm.

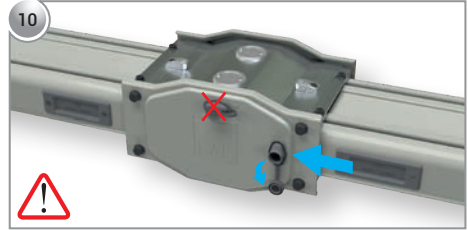

Remove the plastic cover from the casting area as shown in the visual.

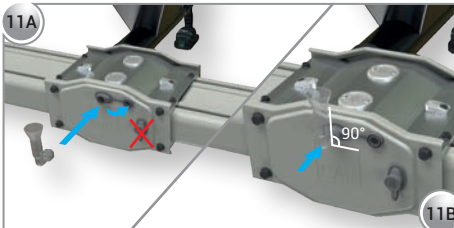

Open the plastic cover on the opposite side of the block joint to be cast, and install the CCR Block Joint Casting Level Control Plastic.

Attention: The level control plastic must be oriented 90° upwards.

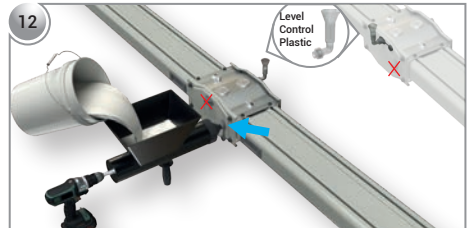

Inject material through the filling hole as shown. Continue filling until Flex-Comp is visible inside the level control plastic.

Attention: Check the Flex-Comp level in the level control plastic. Add more Flex-Comp if it drops.

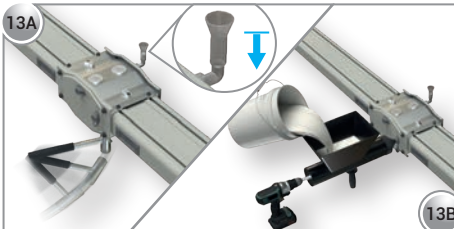

After the initial filling, tap the busbar block joint from underneath with a plastic mallet. If a drop in the Flex-Comp level is observed in the level control plastic during hammering, continue the Flex-Comp filling process through the plastic cap specified in step 12.

Attention: Refilling the process until the Flex-Comp level stabilizes.

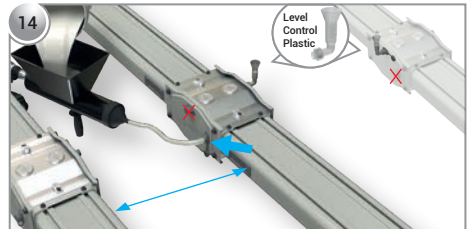

Use a transparent hose in confined spaces to complete the filling process through the indicated filling hole. Continue filling until Flex-Comp is visible inside the control plastic, and apply step 13.

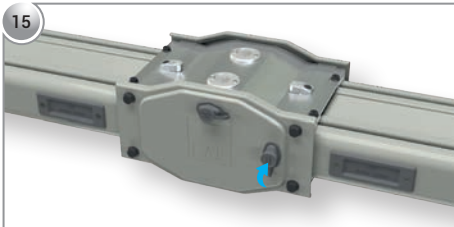

Once the injection process is complete, close the plastic cover and finalize the installation.

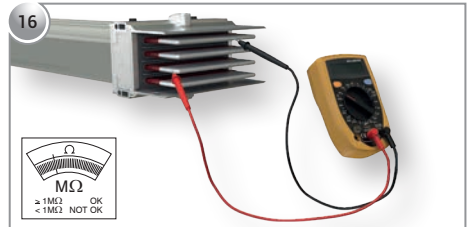

An insulation resistance test must be conducted at least 24 hours after the procedure is completed.

E-LINE CCR MANUAL

►► Installation / Edgewise

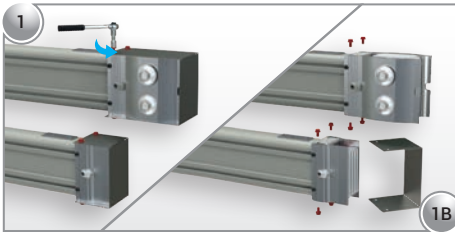

Remove the busbar protection covers by unscrewing the bolts.

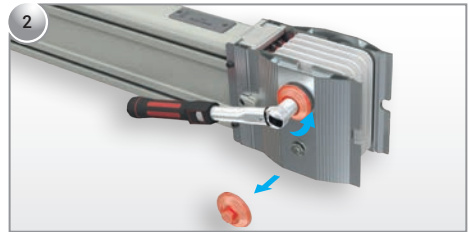

Remove the nut locking cover.



Loosen the block joint nuts.

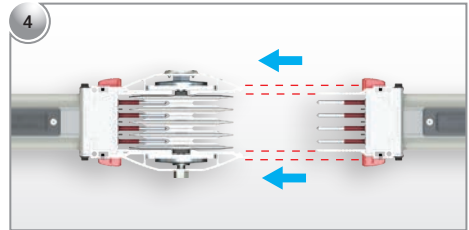

The adjacent busbar is assembled utilizing the alignment pins for correct orientation and alignment of parts. The small alignment pin goes to the small part and the large alignment pin goes to the large part.

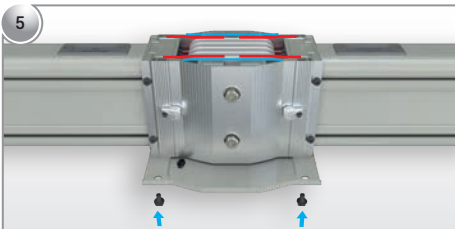

Install the lower block joint cover to align the busbars, tightening the cover bolts to a moderate torque. Adjust until the busbars fit perfectly into the alignment slots.

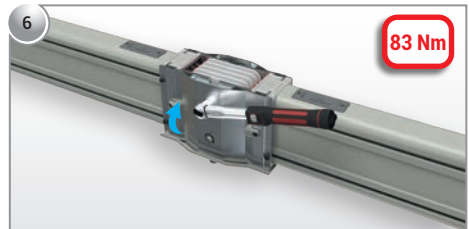

After verifying alignment, torque the block joint nuts to 83 Nm.

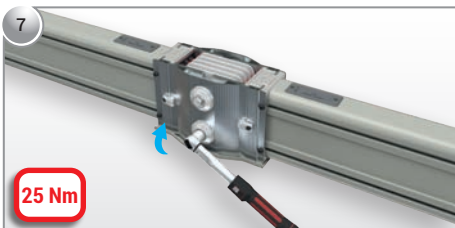

Reinstall the nut locking covers and torque with 25 Nm.

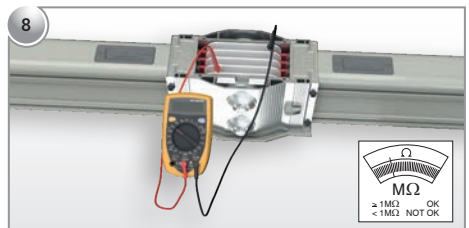

Perform an insulation resistance test between all phases at the installed block joint point

E-LINE CCR MANUAL

►► Installation / Edgewise

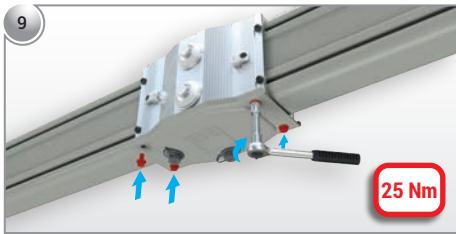

Torque the bolts of the lower block joint cover to 25 Nm.

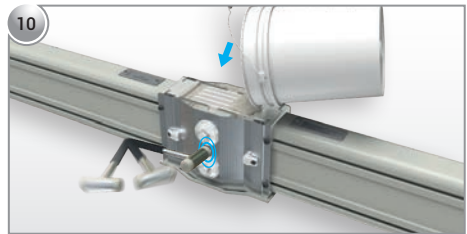

At the open end of the block joint cover, perform the Flex-Comp casting to the top level of the block joint. Apply vibration with a plastic mallet.

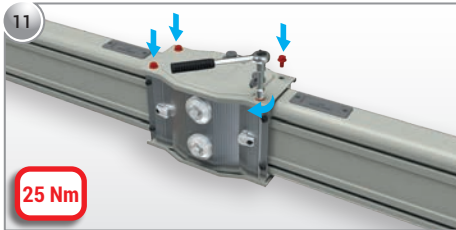

Install the top block joint cover and torque its bolts to 25 Nm.

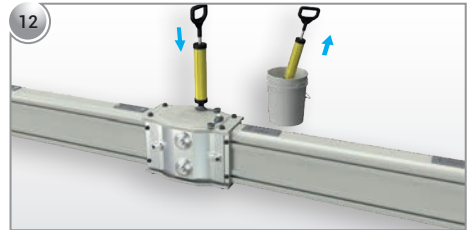

Ensure the injection piston is fitted to prevent leakage at the casting opening and inject Flex-Comp material into the block joint cavity using a lever. Continue injection until Flex-Comp is visible from the other end. Close the plastic cover and finalize the installation.

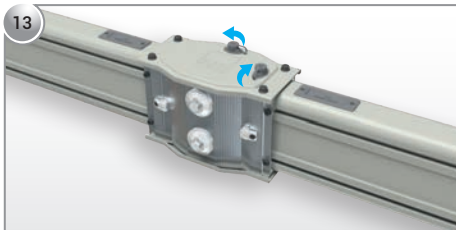

Once the injection process is complete, close the plastic cover and finalize the installation.



An insulation resistance test must be conducted at least 24 hours after the procedure is completed.

E-LINE CCR MANUAL

►► Installation / Vertical

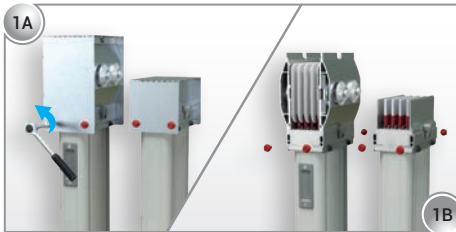

Remove the busbar protection covers by unscrewing the bolts

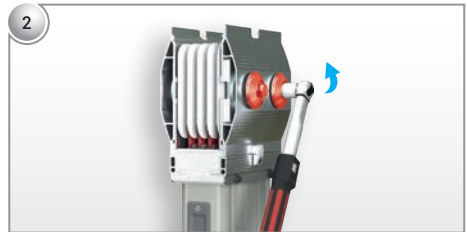

Remove the nut locking cover.

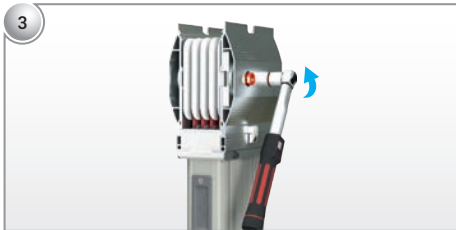

Loosen the block splice nuts.

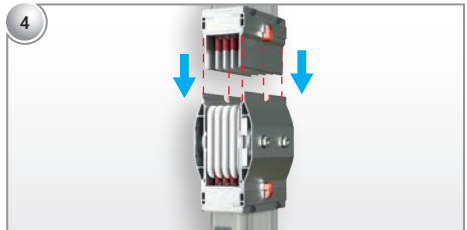

Verify the orientation and compatibility of the busbars and alignment components to be added. Connect the busbars with the small alignment components on top.

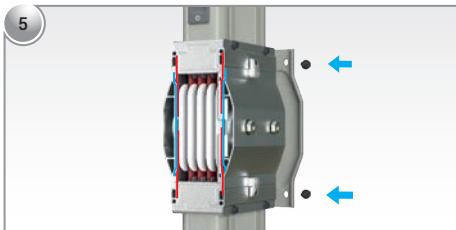

Install the block joint cover to align the busbars, tightening the cover bolts to a moderate torque. Adjust until the busbars fit perfectly into the alignment slots.



After verifying alignment, torque the block joint nuts to 83 Nm.

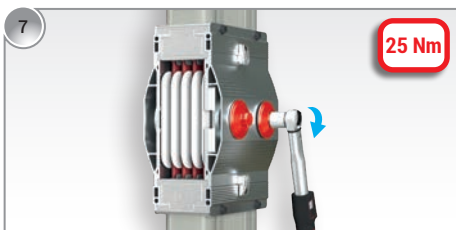

Reinstall the nut locking covers and torque with 25 Nm.



Perform an insulation resistance test between all phases at the installed block joint point.

E-LINE CCR MANUAL

►► Installation / Vertical

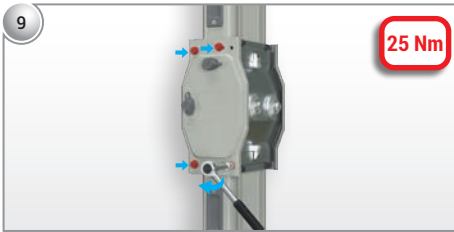

Install the other block joint cover and torque its bolts to 25 Nm.

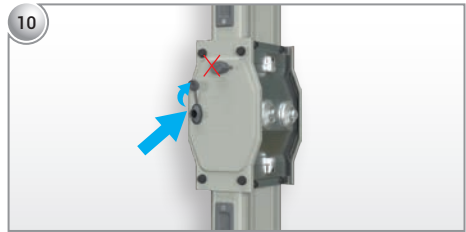

Remove the plastic cover from the casting area as shown in the visual.

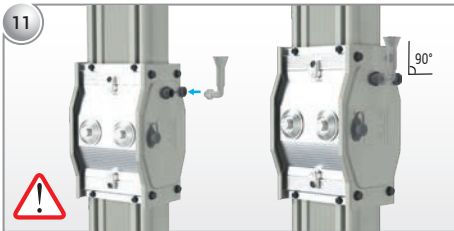

Open the plastic cover on the opposite side of the block joint to be cast, and install the CCR Block Joint Casting Level Control Plastic.

Attention: The level control plastic must be oriented 90° upwards.



Inject material through the filling hole as shown. Continue filling until Flex-Comp is visible inside the level control plastic.

Attention: Check the Flex-Comp level in the level control plastic. Add more Flex-Comp if it drops.

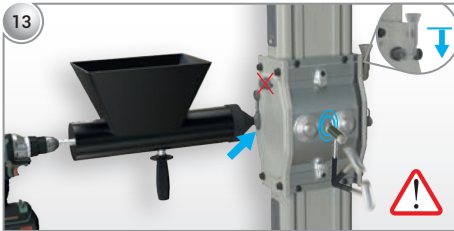

After the initial filling, tap the busbar block joint from underneath with a plastic mallet. If a drop in the Flex-Comp level is observed in the level control plastic during hammering, continue the Flex-Comp filling process through the plastic cap specified in step 12.

Attention: Refilling the process until the Flex-Comp level stabilizes.

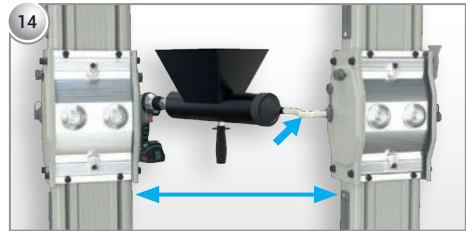

Use a transparent hose in confined spaces to complete the filling process through the indicated filling hole. Continue filling until Flex-Comp is visible inside the control plastic, and apply step 13.



Once the injection process is complete, close the plastic cover and finalize the installation.



An insulation resistance test must be conducted at least 24 hours after the procedure is completed.

E-LINE CCR MANUAL



►► Electrical site-tests

► EJunction Resistance Test

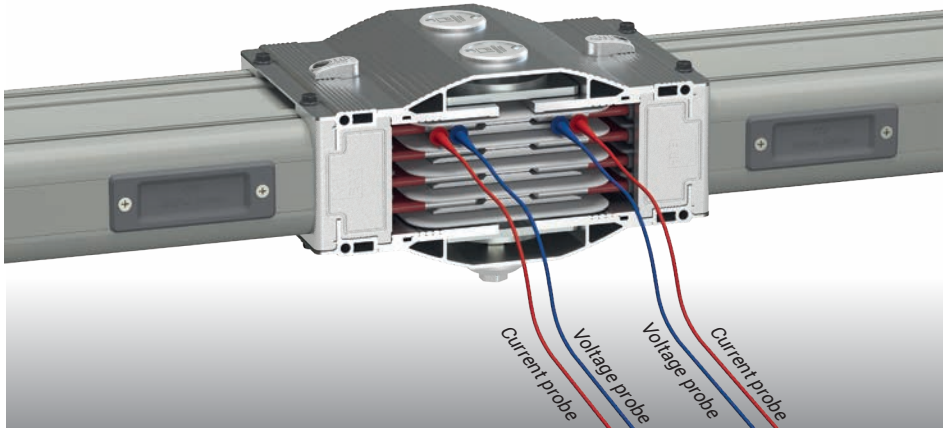

$$R_{\max} \leq 15 \mu\Omega$$

► Line Insulation Resistance Test

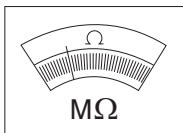
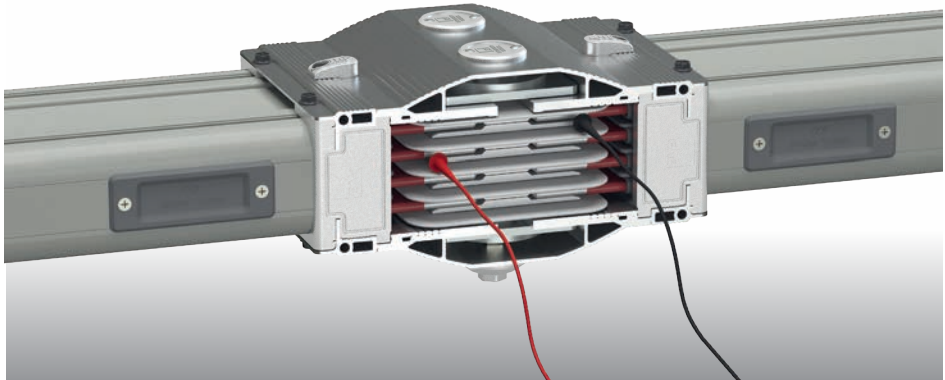

$\geq 1\text{M}\Omega$ OK
 $< 1\text{M}\Omega$ NOT OK

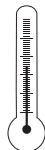

$< 5^\circ\text{C}$ → STOP
 $> 35^\circ\text{C}$ → STOP

T(°C)

E-LINE CCR MANUAL

►► Annex A Site Joint Test Instruction



PURPOSE

Joint resistance must be measured to ensure contact quality and to prevent the busbar from overheating during operation. The purpose is to measure the joint resistances of CCR type of busbars' of EAE branded.

SCOPE

This test instruction covers CCR type of EAE branded busbars whose joint resistance is to be measured. Since the measurement of joint resistance is not defined in the relevant busbar standards, this test instruction has been prepared based on OHM law.

APPLICATION OF THE TEST

The OHM law is based on a four-wire measurement in this test: a constant current is injected and the resulting voltage drop is used to calculate the resistance.

Joint resistance measurement points for a representative joint connection are given in Figure 1.

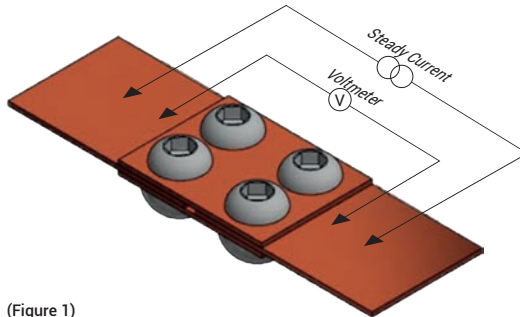

(Figure 1)

The diagram given in Figure 1 is a reference for joint resistance measurement for all kinds of joint connections.

Joint connections may differ in different product types, but basically, measurement in all joint structures is based on the same logic.

E-LINE CCR MANUAL

►► Annex A Site Joint Test Instruction



Joint structures of EAE busbars of CCR model is shown in the drawing below.

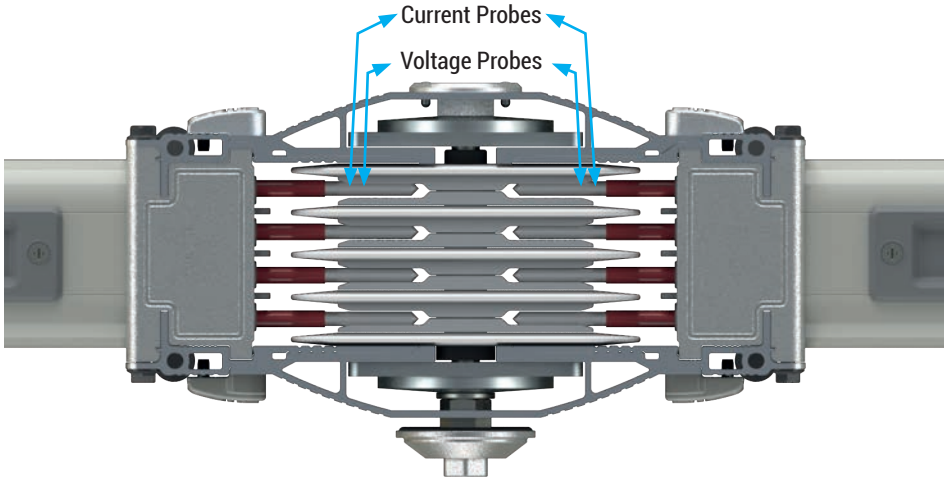

Measurements should be made with a four-wire DC low resistance.

The probes of the device should be connected to the joint structure as shown in Figure 1. A four-wire, calibrated OHM meter that applies at least DC 10 Amperes should be preferred.

The most suitable measuring probes should be used according to the joint structure.

As shown in Figure 1, joint resistance measurements are made after the measurement probes are connected to the joint connection.

Joint transition resistance measurements are repeated at least twice to ensure the measurement result.

The difference in resistance value measured for L1, L2, L3 and N conductors in the same joint can not be more than 10 $\mu\Omega$.

Joint transition resistance measured for PE conductor can not be more than 100m Ω .

Maximum joint transition resistance is 25 $\mu\Omega$. All values below this value are considered acceptable.

E-LINE CCR MANUAL

►►EAE Electrical Site Test Report



► Junction Resistance Test Report

Customer:				Date:/...../.....	
Project:				Order No:	
Address:				U _n : V	I _n : A	
Busbar Code:			Material: AL <input type="checkbox"/> CU <input type="checkbox"/>	Conductor Section: x mm ²	
Line:				Required Torque:	M12	83Nm
Note: The tests have to perform only with calibrated devices.				Calibration Date:/...../.....	

Results

Junction :		Junction :		Junction :		Junction :		Junction :	
Phase	R (μΩ)	Phase	R (μΩ)	Phase	R (μΩ)	Phase	R (μΩ)	Phase	R (μΩ)
N - N		N - N		N - N		N - N		N - N	
L1 - L1		L1 - L1		L1 - L1		L1 - L1		L1 - L1	
L2 - L2		L2 - L2		L2 - L2		L2 - L2		L2 - L2	
L3 - L3		L3 - L3		L3 - L3		L3 - L3		L3 - L3	
PE - PE		PE - PE		PE - PE		PE - PE		PE - PE	
Torque: Nm	Torque: Nm	Torque: Nm	Torque: Nm	Torque: Nm
Max Value: μΩ	Max Value: μΩ	Max Value: μΩ	Max Value: μΩ	Max Value: μΩ
Junction :		Junction :		Junction :		Junction :		Junction :	
Phase	R (μΩ)	Phase	R (μΩ)	Phase	R (μΩ)	Phase	R (μΩ)	Phase	R (μΩ)
N - N		N - N		N - N		N - N		N - N	
L1 - L1		L1 - L1		L1 - L1		L1 - L1		L1 - L1	
L2 - L2		L2 - L2		L2 - L2		L2 - L2		L2 - L2	
L3 - L3		L3 - L3		L3 - L3		L3 - L3		L3 - L3	
PE - PE		PE - PE		PE - PE		PE - PE		PE - PE	
Torque: Nm	Torque: Nm	Torque: Nm	Torque: Nm	Torque: Nm
Max Value: μΩ	Max Value: μΩ	Max Value: μΩ	Max Value: μΩ	Max Value: μΩ

The maximum values per type and explanation to execute this test can be found in Annex A Electrical Site Tests of CR Manual

Remarks

Witnesses

Name	Company	Date	Signature

E-LINE CCR MANUAL

►►EAE Electrical Site Test Report



► Line Insulation Resistance Test Report

Customer:		Date:/...../.....
Project:		Order No:
Address:		U_s : V	I_s : A
Busbar Code:		Material: AL <input type="checkbox"/> CU <input type="checkbox"/>	Conductor Section: x mm ²
Line:		Result by: V (DC)
Note: The tests have to perform only with calibrated devices.		Calibration Date:/...../.....

Recommended Test Voltage 1000 V DC

Results

	Before Casting	After Casting	
N - L1	=	/	MΩ
N - L2	=	/	MΩ
N - L3	=	/	MΩ
N - PE	=	/	MΩ
L1 - L2	=	/	MΩ
L1 - L3	=	/	MΩ
L1 - PE	=	/	MΩ
L2 - L3	=	/	MΩ
L2 - PE	=	/	MΩ
L3 - PE	=	/	MΩ

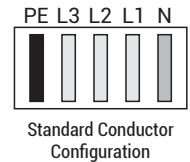

Remarks

Witnesses

Name	Company	Date	Signature

CE DECLARATION OF CONFORMITY

Product Group	E-Line CCR Busbar Energy Distribution System
Manufacturer	EAE Elektrik Asansor End. Insaat San. ve Tic. A.S. Akcaburgaz Mahallesi, 3114. Sokak, No:10, 34522 Esenyurt - Istanbul

The objects of the declaration described below is in conformity with the relevant Union harmonisation legislation. This declaration of conformity is issued under the sole responsibility of the manufacturer.

Standard:

TS EN 61439-6

Low-voltage switchgear and controlgear assemblies - Part 6: Busbar trunking systems (busways)

CE - Directive:

2014/35/EU "The Low Voltage Directive"

2014/30/EU "Electromagnetic Compatibility (EMC) Directive"

Technical Document Preparation Official ;

EAE Elektrik Asansor End. Insaat San. ve Tic. A.S.
Akcaburgaz Mahallesi, 3114. Sokak, No:10 34522 Esenyurt-Istanbul

Mustafa AKÇELİK

Date

03.03.2024

Document Authorized Signatory

Elif Gamze KAYA OK
Deputy General Manager



E-LINE CCR MANUAL

►► Certificates



<p>For the product: Low-voltage busbar trunking system</p>			
<p>Requirements: IEC 61438-6:2012; Clauses: 10.2.3, 10.2.8, 10.2.7, 10.2.10, 10.3, 10.4, 10.5, 10.9, 10.10, 10.11 and Annex BB, CC, and DD</p>			
<p>its length is limited by its own responsibility</p>			
	<p style="text-align: center;">DEKRA Certification B.V.</p> <p style="text-align: center;">F.S. Strikwerda Certification Manager</p> <p style="text-align: center;">This certificate and adjoining reports is allowed</p>		

DEKRA Certification B.V. Utrechtseweg 310, 6812 AR Arnhem, P.O. Box 5185, 6802 ED Arnhem, The Netherlands
 T +31 85 96 83000 F +31 85 96 83100 www.dekra-certificator.com Company registration 09085398

600A...6300A COMPACT BUSBAR PRODUCT OVERVIEW (E-LINE CCR)

1- Standards & Certification:

-Busbar trunking system shall be designed, type tested and, manufactured in accordance with the International standard IEC 61439-6. Type test shall be documented by independent and internationally accredited testing and certification bodies. Short circuit type tests shall be conducted by independent and accredited testing and certification bodies. Short circuit type tests and the following 3 main type tests shall be conducted for each current rating of the busbar system and conformity to the standards certificates obtained.

2- General Structure Of The System

-The busbar system should be low impedance in accordance with the following characteristics. The tin coated conductors are arranged as a sandwich construction inside the resin body without any air gaps.

2.1- Electrical Characteristics

-Busbar systems nominal insulation voltage shall be 1000V
-As per ampere rates, minimum short circuit values shall be as given below;

For Aluminium Conductors;

600A	: 1 sec/rms	25kA, peak	52,5kA
800-1250A	: 1 sec/rms	35kA, peak	73,5kA
1600A	: 1 sec/rms	60kA, peak	132kA
2000A	: 1 sec/rms	80kA, peak	176kA
2500A and above	: 1 sec/rms	100kA, peak	220kA

For Copper Conductors;

650-850A	: 1 sec/rms	35kA, peak	73,5kA
1000A	: 1 sec/rms	50kA, peak	105kA
1250-1600-2000A	: 1 sec/rms	80kA, peak	176kA
2500-3200A	: 1 sec/rms	100kA, peak	220kA
3400A and above	: 1 sec/rms	120kA, peak	264kA

2.2- Housing

-The housing of the busbar system shall be manufactured with specially developed cast material.

-The structure of the busbar lengths shall have conductors tin plated along their complete length within the housing.

-Multi-path busbars should be combined in a single body so that they are not separated from each other.

-Up and down, right-left turn elements, "T" and offset elements, panel, transformer and cable connectors, termination, horizontal and vertical expansion elements should be standard in the Busbar trunking system. Special modules and different lengths busbar ducts that may be required during the application of the project must be manufactured in a short time in accordance with standard specifications and technology.

-If busbar runs pass through the building expansion joint a horizontal expansion element shall be used in the run. In addition horizontal expansion elements should be used every 40 m along a horizontal run.

2.3- Conductors and Phase Configuration

- Compact busbar system shall have aluminium conductors between 600A – 5400A.
- Compact busbar system shall have copper conductors between 650A – 6300A.
- Busbar system shall have the following number of conductors and wire configuration.

- a) 3 Conductors
- b) 4 Conductors
- c) 4 ½ Conductors
- d) 5 Conductors

- Neutral conductor shall have the same cross section as the phase conductor cross section.
- Aluminium conductors shall be of EC grade aluminium. Minimum conductivity shall be 34m/mm².Ω. All surfaces of aluminium conductors shall be tin plated.
- Copper conductors shall be minimum 99,95% electrolytic copper. Minimum conductivity shall be 56m/mm².Ω. all surfaces of electrolytic copper conductors shall be tin plated.

2.4- Insulation

- Busbars shall be insulated using a mixture of specially selected silica and calcite mixed with an electrical grade epoxy resin to make a superior composite material. This insulation material must have a high impact resistance against external impacts.

2.5- Modular Joint Construction

- The busbar lengths must be joined together with the joint's point drawer type modular block joint system by placing the conductors in the conductive socket in the block insert. Joint block insulators should be high strength CTP insulators. The joint block's centre bolt should be tightened with a torque wrench set to 83 Nm (60 lb ft) after installation.

2.6- Protection

- Protection degree of the housing and joints shall be IP68.

3- Installation and Commissioning

- The installation of the busbar system should be done in accordance with the type and current values shown in these plans in accordance with the electrical project, electrical single line schemes, layout plans and detailed busbar application projects, the manufacturer's installation instructions must be observed carefully during the assembly process. The central joint's bolts must be tightened with the appropriate torque wrench and the nut side of the bolt must be secured with the nut locking cap.
- After installation of the busbar system the installation should be checked for compliance with the manufacturer's instructions and the requirements of the project, an insulation test should be done. Insulation resistance between all conductors and body has to be bigger than 1 megaohm.

EAE Elektrik A.S.
Head Office
Akcaburgaz Mahallesi,
3114. Sokak, No:10 34522
Esenyurt - Istanbul - TURKEY
Tel: +90 (212) 866 20 00
Fax: +90 (212) 886 24 20

EAE DL 3 Factory
Busbar
Gebze IV Istanbul Makine ve Sanayicileri
Organize Bolgesi, 6. Cadde,
No: 6 41455 Demirciler Koyu,
Dilovasi – Kocaeli - TURKEY
Tel: +90 (262) 999 05 55
Fax: +90 (262) 502 05 69



Manual 58-En. / Rev 09 00 pcs. 04/10/2024
D.S.

EAE has full right to make any revisions or changes on this catalogue without any prior notice.

